



**LOZOVA  
MACHINERY**

**TILLAGE MACHINERY**



# CONTENTS



**DUCAT**  
Compact disc harrow

page 4



**DUCAT GOLD**  
Heavy disc harrow

page 8



**FRANC and GULDEN**  
Subsoilers

page 11



**LIRA**  
Hydraulic spring-tooth harrow

page 14



**LIRA-XL**  
Heavy tooth harrow

page 17



**LARI**  
Heavy tooth drag harrow

page 20



**FLORIN**  
Multipurpose field cultivator

page 23



**"Lozova Machinery"** adheres to two principles.

We named the machines in our product line after world currencies because money invested in our equipment indeed works for you in the fields.

**"Make Your Money Work!"** - is the first our motto.

Buying LOZOVA MACHINERY, farmers get maximum machine performance with minimum maintenance and life cycle costs.

We were the first and, in many respects, we remain the only ones who have practically implemented the principle of **"Zero Maintenance"** in tillage equipment.

This is not only because we have been on the agricultural machinery market for more than 70 years, and not only because we are a diversified Group and our bearing company is the developer of unique HARP Agri units, but above all because in our R&D we adhere to the principle **"To help farmer think like a farmer!"**

**Anatoliy Girshfeld**, President of LOZOVA MACHINERY PRODUCTION / UPEC GROUP

Lozova Machinery Production LLC (part of UPEC Group) represents a wide range of up-to-date cost-effective tillage implements (more than 30 serially-produced tillage units - tooth, disc and rotary harrows, cultivators, subsoilers), seeding machinery and tipping trailers.

All implements are designed to provide farmers with maximum effect: better and faster tilling, unique «Zero Maintenance» concept (the equipment does not need lubrication / re-lubrication and other types of standard maintenance throughout its entire life cycle), no downtimes and repairs, fuel saving.

Thanks to the innovations the equipment of LOZOVA MACHINERY has:

- Increased reliability and a sharp reduction in maintenance (complete elimination of periodic lubrication);
- Exclusion of environmental risks (caused by the ingress of the part of old or new grease on the ground);
- Increasing economic efficiency (reducing operating cost);
- Elimination of the risk of the impact of poor-quality maintenance of machines on their performance.

Our engineering solutions are original, protected by patents and inventor's certificates. Within the R&D of implements the whole complex of math simulations and 3-d shape strength-weight optimization is realized. Before launching mass production LOZOVA MACHINERY units undergo several stages of tests.

**TO HELP A FARMER WE ARE THINKING LIKE A FARMER!**

**MAKE YOUR MONEY WORK!**

Stubble cultivation, primary tillage,  
seedbed preparation



# DUCAT

## COMPACT DISC HARROWS



TRADITIONAL  
and ORGANIC

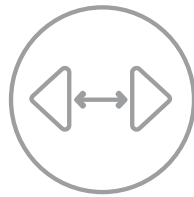

2,5 - 12 m  
8' - 40' ft



min 80 hp

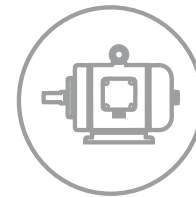

min 20 ha/h  
up to 50 acre/h

## RESULT IN ONE PASS

The DUCAT compact disc harrows are presented as a full range of highly-efficient implements with working widths of 2.5 m to 12 m (from 8' to 40').

DUCAT disc harrow is the best solution for stubble cultivation. It provides intensive mixing of the soil and vegetation at a depth from 3 to 14 cm (1.2"-5.5").

It can be used both for early spring and fall tillage.

DUCAT is applied for:

- stubble cultivation;
- mulching;
- shallow and surface basic cultivation;
- seedbed preparation.







**3D spring tine**

3D spring tine provides:

- vibration in horizontal and vertical planes
- reduce of the implement draught and fuel consumption by over 20%
- uniform cultivation depth as the harrow doesn't raise when one of the discs hits an obstacle
- disc self-cleaning which ensures efficient operation on the wet soil.



**Premium class discs**

- discs are made of high-quality hardened boron steel (Bellota, OFAS) and have longer service life (work two times longer than analogues)
- discs spacing of 125 mm (4.9") and low frequency lateral tine vibrations provide a seedbed even by depth and without deep furrows
- working tools attack angle is 20°
- soil entry angle is 12°.

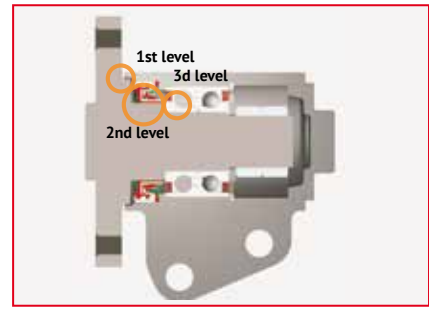

**High strength bearing unit**

DUCAT disc harrows are equipped with original super-reliable bearing units. HARP AGRO UNIT is a maintenance-free bearing unit, optimized for application in agricultural machinery. HARP AGRO UNIT has three-level protection (labyrinth cutter, high quality cassette sealing, integrated reinforced lip-type sealing).

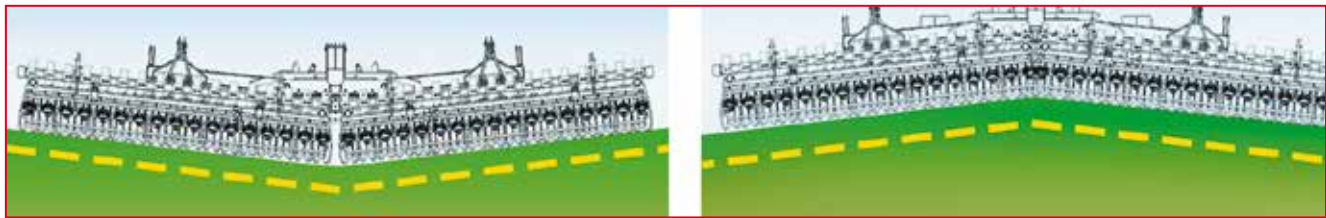

**High-quality contours following for perfect cultivation**

Application of the different following systems with uniform distribution of loads on the working elements allows efficiently operating on fields with complex contours. Design of the DUCAT provides precise depth control and good levelling.

3D spring tine provides maximum protection of the bearing unit when hitting any obstacles which prevents damage of discs, bearings, tines and frame.





**Roller maintenance-free bearing unit**

Bearing unit of the roller is maintenance-free for entire service life due to high-quality cassette sealings and HARP-AGRO fully sealed bearings. Roller axles are mounted on the cage by means of rubber buffers, which additionally reduce absorbed loads of the bearing unit.

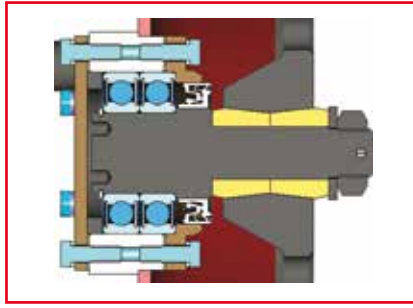

**Unique bearing HARP-AGRO**

Sealed bearing HARP-AGRO with high-quality Chevron grease does not require additional lubrication for the entire life cycle.

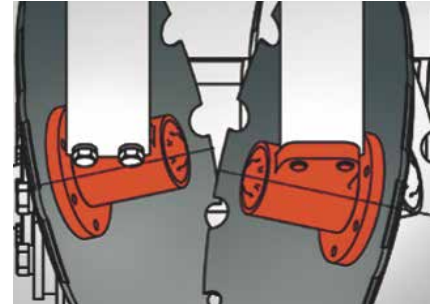

**Furrow problem is solved**

Due to mounting of the bearing unit on the other side of the tine, the problem of furrow from the outer disc is solved (additional parts are not necessary).

### TECHNICAL DATA

	DUCAT-2,5	DUCAT-3	DUCAT-4	DUCAT-4M	DUCAT-5	DUCAT-6	DUCAT-8	DUCAT-9	DUCAT-12
Working width, m; ft	2,5/8'	3/9'	4/13'	4/13'	5,25/17'	6,25/20.5'	8,25/27'	9,25/30'	12,25/40'
Tractor power, hp	min 80	min 100	min 130	min 130	min 150	min 170	min 250	min 300	min 350
Coupling with tractor	mounted			semi-mounted		semi-trailed			
Basic weight, kg; lbs	1050	1400	1600	2300	3820	4572	8285	8859	10348
Number of discs	20	24	32	32	42	50	66	74	98
Disc diameter, mm; inch	566/22"								
Overload protection	3D-protection								
Operating depth, cm; inch	3–12/1.2"-5"				3–14/1.2"-5.5"				
Operating speed, km/h; mph	10–17/6-10								
Efficiency, ha/h	max 3,4	max 4,1	max 5,5	max 5,5	max 6,7	max 8	max 10,5	max 11,8	max 15,6
Fuel consumption, l/ha; gal/ac	321"x118"x157" 4,5–5,5/0.5-0.6								
Transport dimensions (length x width x height), mm; inch	2456 x 2691 x 1450 96"x 106"x 58"	2456 x 3000 x 2000 96"x 118"x 79"	2456 x 4190 x 1550 96"x 165"x 61"	2839 x 3000 x 2371 111"x 118"x 93"	5832 x 3000 x 3205 229"x 118"x 126"	5832 x 3000 x 3746 229"x 118"x 147"	6832 x 3000 x 3330 269"x 118"x 131"	7332 x 3000 x 3330 288"x 118"x 131"	8832 x 3000 x 3330 347"x 118"x 131"

## WIDE VARIETY OF ROLLERS

For optimal packing, DUCAT can be equipped with rollers of various types:

Cage roller



For all types of soil

Packing tooth roller



For dry soils of all types

Double U roller



For all types of soil with  
big amount of crop residues

Rubber roller



For seedbed preparation

Pack ring roller



For wet soils of all types





Stubble cultivation, primary tillage,  
seedbed preparation



# DUCAT GOLD

## HEAVY DISC HARROWS

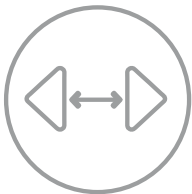

6 - 8 m  
20' - 26' ft



min 300 hp

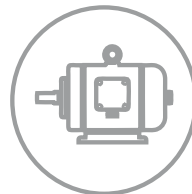

min 10,2 ha/h  
min 2,47 acre/h



724 mm  
28" inch

## GOLD STANDARD OF DISC HARROWING

DUCAT GOLD is the most optimal harrow for work on heavy stubble and untilled fields. Disc with diameter of 724 mm (28") has tilt and attack angle. Load per disc is 260 kg (573) lbs.

The discs and rollers are equipped with durable

maintenance-free bearing units.

The harrow ensures uniform mixing of the soil and plant residues to a depth 5-20 cm (2"-8") without blocking of discs even when there is a big amount of organic mass (including corn and sunflower).







### New bigger discs

Diameter of discs is 724 mm (28"). They cope with any stubble remains at the depth up to 20 cm (8").



### Tines made of high-strength steel

Tines are made of high quality steel and endure high loads on dry soil. Attack angle of discs is 20°, while the angle to the movement direction is 12°. This provides fast discs penetration into the soil and uniform tillage, as well as an optimal combination of chopping and mixing of the soil with crop residues.

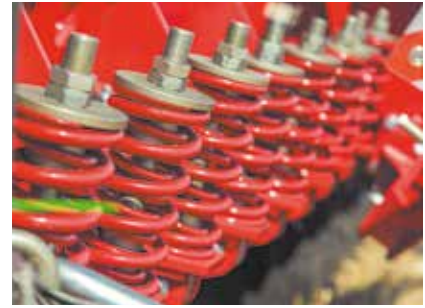

### Tine protection

Double spring creates an optimal pressure on the tine, which keeps working depth when destroying remains of rough crops, and protects it from overloads.



### Rollers

Rollers with diameter of 600 mm (24") provide good load-bearing capacity on light soils.

Rollers are equipped with maintenance-free bearing units HARP AGRO UNIT.

Heavy roller provides an optimal compacting of loosened soil.

Depth set up is quite simple as rollers are adjusted from tractor cab by hydraulics.



### Smooth run and thorough work

Heavy disc harrow is equipped with a balance drive system, which provides a smooth run during work and transportation by public roads and cross country.



### Hydraulic protection

DUCAT GOLD has a hydraulic lock for safe transportation of folded machine, which is activated by the tractor's hydraulic system.



### HARP AGRO UNIT

Special bearing units have been developed for DUCAT GOLD (from HARP AGRO UNIT series, which are widely used in agriculture machines and provide failure-free operation for a long term).

Bearing units have enhanced durability due to superreliable three-level protection of bearings, which, in turn, don't require additional lubrication.

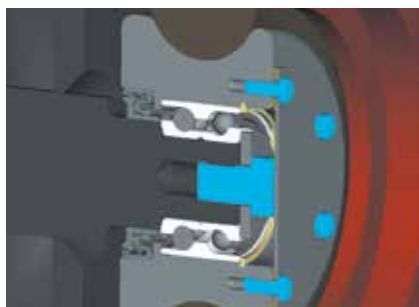

### Reliable bearings of roller

Roller is equipped with a special maintenance-free bearing unit HARP AGRO UNIT. There is an additional rubber ring around the bearing which prevents axial misalignments and absorbs shock loads. The X-SHIELD sealing protects bearing from moisture and dirt.



### Maintenance-free tines

Tines are equipped with plain bearings, so there is no additional lubrication points, and maintenance-free period is increased.

Plain bearings are durable and designed for medium and heavy loads at small speeds and high vibration level. Bearings are mounted on three points of the tine and distinguished with low friction rate, good wear resistance and shock absorbing.

## TECHNICAL DATA

	DUCAT GOLD-6	DUCAT GOLD-8
Working width, m; ft	6/20'	8/26'
Tractor power, hp	min 300	min 400
Coupling with tractor	semi-trailed	semi-trailed
Weight, kg; lbs	10 705/23.600*	13 459/29.672
Number of discs, pcs.	38	50
Disc with big diameter, mm; inch	724/28"	724/28"
Load per disc, kg; lbs	280/617	270/595
Heavy tine	spring block	spring block
Operation depth, cm; inch	5-20/2"-8"	5 - 20/2"-8"
Operation speed, km/h; mph	10-17/6-10	10-17/6-10
Efficiency, ha/h; acre/h	max 9/22	max 10.2/2.47
Fuel consumption, l/ha; gal/ac	max 9/0.96	max 9/0.96
Transport dimensions (length x width x height), mm; inch	8151 x 3000 x 4000 321"x118"x157"	7495 x 3970 x 4000 295"x156"x157"



Subsoiling



# FRANC & GULDEN

SUBSOILERS

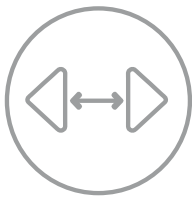

2,5 - 4 m  
8' - 13' ft



min 160 hp

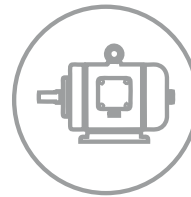

min 3,6 ha/h  
8.8 acre/h

## THE BEST ALTERNATIVE TO PLOWING

FRANC and GULDEN subsoilers are designed for solid one- and two-level nonmoldboard cultivation instead of fall and spring tillage, chiselling on the slopes and leas, post-harvest loosening and seedbed preparation of stubble and mulch backgrounds, eroded soils, as well as for cultivation of the long-fallow and forage lands.

The implements perform chisel tillage, leaving on the surface 30-60% of crop residues, which solves the problem of soil erosion, maintaining the organic composition of the soil and ensuring its long-term fertility.

... AND SOIL BREATHES!



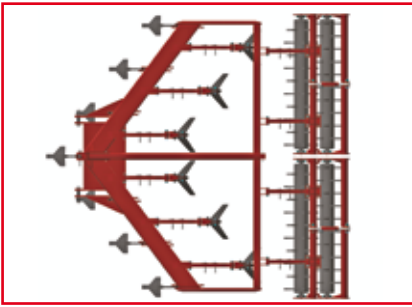

**Deltaic frame**

Deltaic frame is made of shaped tube in the form of an isosceles triangle, which redistributes efforts and reduces loads on the frame.



**Application benefits**

FRANC and GULDEN subsoilers break the plough-pan and recover the soil, encouraging roots development and free circulation of water and nutrients.



**Straight tine benefits**

High strength straight tine penetrates into the soil at right angle, without side moving of the soil and requires lower draft.

## HARD-SHELL — SHARE POINTS FOR FRANC AND GULDEN SUBSOILERS



### THREE TIMES LONGER WORK!

- The main feature of HARD-SHELL quick-change hardmetal point is long term durability. HARD-SHELL significantly reduces maintenance costs and provides high quality work at constant depth. The point is welded and can be mounted both on FRANC and GULDEN.
- Hardness is more than 88 HRC.

- Quick-change point made of boron steel with built-in wings for GULDEN. Shares with wings subsoil and loosen the top soil very well. Hardness is more than 88 HRC.







**Self-cleaning roller**

The subsoiler is equipped with double tooth roller.

Teeth break large clods thrown on the surface, prepare and level the soil, facilitating further final seedbed preparation. Rotating teeth embed crop residues into the lower layers of soil and mix them with soil at depth of 15-20 cm (6"-8").



**Roller balancing mounting**

Balancing mounting of the double roller provides the constant contact of both rollers with the soil.

Depending on purposes the rollers can be adjusted either for uniform work and work with accent on front/rear roller.



**Premium class bearing unit**

Subsoilers are assembled with superreliable maintenance-free HARP AGRO UNIT bearing units. Application of high-quality German plain bearings prevents wear of the roller adjustment mechanism rotary units.

In fact, only flanged bearing unit of the roller may require additional lubrication.

#### TECHNICAL DATA

	FRANC-2,5	FRANC-3	GULDEN
Working width, m; ft	2.5/8'	3/9'	4/13'
Tractor power, hp	min. 160	min. 240	min. 350
Coupling with tractor	mounted	mounted	mounted
Basic weight, kg; lbs	1355/2.987	1650/3.637	2522/5.560 2892/6.375
Number of tines, pcs.	5	7	front row - 7. rear row - 6
Operating depth, cm; inch	max. 45/18"		front row up to 45/18" rear row up to 25/10"
Operating speed, km/h; mph	8-12/5-7.5		8-12/5-7.5
Efficiency, ha/h; acre/h	max. 2.23/5.5	max. 2.88/6.6	max. 3.58/8.8
Fuel consumption, l/ha; gal/ac	10-18/1.1-1.9		10-18/1.1-1.9
Transport dimensions (length x width x height), mm; inch	2860x2479x1885 113"x98"x74"	2940x3000x1950 116"x118"x76"	4344x4054x2053 171"x160"x81"



# LIRA

## HYDRAULIC SPRING-TOOTH HARROWS



TRADITIONAL  
and ORGANIC

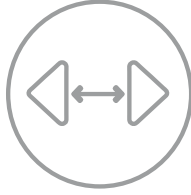

15-24 m  
49' - 79' ft



min 80 hp

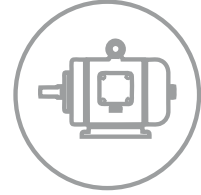

max 28,8 ha/h  
max 48 acre/h

## LEGENDARY LIRA

The LIRA spring harrow is applied for:

- early spring harrowing for crust destruction and encouraging the weeds germination;
- weeds destruction in the "white fiber" phase;
- moisture retention by means of interruption of capillary flow from the substrate;
- even distribution of stubble remains on the field;
- incorporation of seeds and mineral fertilizers, distributed across the field;
- overall tillage when handling the fallow lands and seedbed preparation when fall-ploughing;
- windrowing of straw and hay.

Applying LIRA harrow would allow not only to kill the weeds without the expensive chemicals, but also retain moisture and provide air access to seeds.





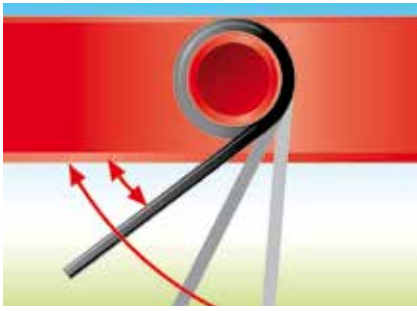

**Improved tillage quality**

Work sections consist of five rows of the offset spring teeth with spacing of 38 mm (1.50") between them. Such arrangement doesn't leave non-cultivated areas on the field. Careful cultivation is provided by the adjustable tilt angle of teeth. The teeth tilt angle is adjusted for entire section with limits from 15° to 90°, and interval of 15°. Blockage-free work of teeth and perfect loosening are provided by vibration effect.



**Premium class spring tooth**

The spring tooth diameter is 10 mm (0.39"), but application of innovative hardening significantly (in 2-3 times) increases the tooth wear resistance accounting for the torque stresses.

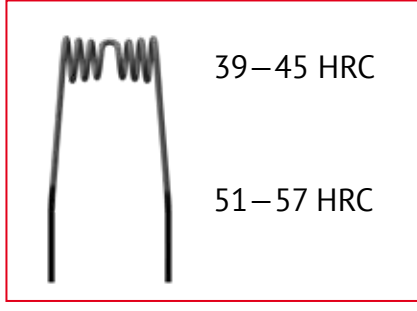

**Long service life**

The spring tooth is made of high-quality special steel with special heat treatment: general bulk hardening and additional HFC hardening of ends up to 51-57 HRC.

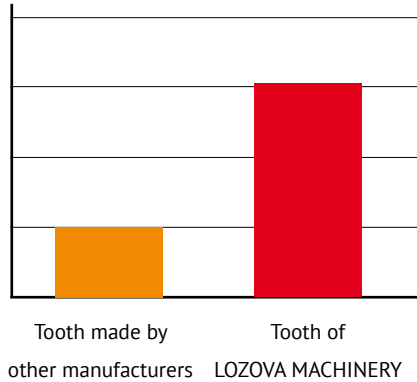

Lifetime of our tooth is three times higher than tooth of other manufacturers.

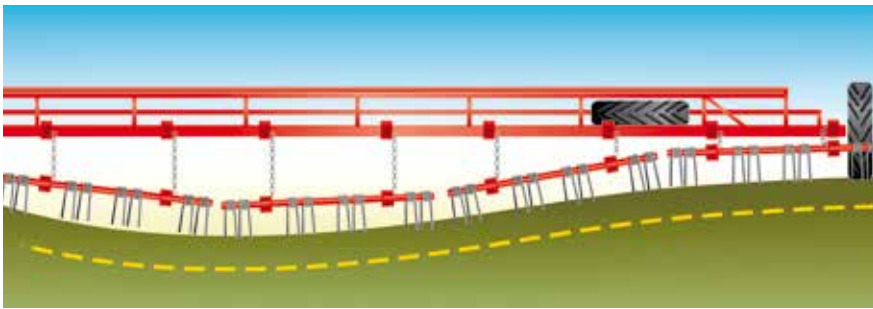

**Precise and careful soil treatment**

Having the chained individual working sections, the LIRA spring harrow perfectly follows any field contours in spite of its wide working width.

Special agricultural low-pressure tires almost fully eliminate the risk of damage to plants. Also tires eliminate overcompacting of the soil and don't leave tracks.



**Forged cross**

Forged crosses that connect central and side frames, in comparison to welded ones, provide higher durability and reliability.



### Advantages LIRA M

Telescopic rigid drawbar for prevention of semi-frames toe-in during quick turns of transport.

Hydraulically controlled transport wheel for simple folding/unfolding.



### Durable teeth

Zero-maintenance conception due to use of lubrication-free crosses.



3 m  
9' ft

Tooth harrows LIRA of the "M" series have a reduced transport width of 3 meters corresponding to traffic regulations of the EU countries

### TECHNICAL DATA

	LIRA-15	LIRA-24	LIRA M-12	LIRA M-15	LIRA M-18	LIRA-21M	LIRA-24M
Working width, m; ft	15/49'	24/79'	12/39'	15/49'	18/59'	21/68'	24/78'
Tractor power, hp.	min 80	min 130	min 60	min 80	min 100	min 130	min 150
Tractor power, hp.	trailed						
Basic weight, kg; lbs	2030/4.480	3160/6.944	1995/4.398	2280/5.026	2575/5.676	2950/6.944	3280/7.231
Number of working tools	200	320	153	193	233	273	313
Teeth spacing, mm; inch	38/1.50"						
Teeth tilt angle, °	15, 30, 45, 60, 75, 90						
Operating depth, cm; inch	max 9/3.54"						
Operating speed, km/h; mph	8...15/5-9						
Efficiency, ha/h	max 18	max 28,8	max 14.4	max 18	max 21.6	max 24,8	max 28,8
Fuel consumption, l/ha; gal/ac	0,8...1,5/0.9-0.16						
Transport dimensions (length x width x height), mm; inch	10455 x 3710 x 2390 411"x 146"x 94"	17170 x 4400 x 2390 675"x 173"x 97"	9568 x 3000 x 2190 376"x 118"x 86"	11090 x 3000 x 2190 436"x 118"x 86"	12614 x 3000 x 2190 496"x 118"x 86"	16053 x 3000 x 2402 633"x 118"x 94"	17580 x 3000 x 2402 692"x 118"x 94"





# LIRA XL

## HEAVY TOOTH HARROW



TRADITIONAL  
and ORGANIC

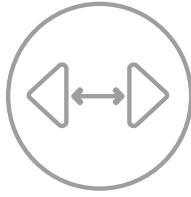

15-21 m  
49' - 69' ft



min 160 hp

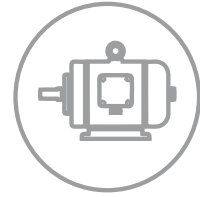

max 25,2 ha/h  
max 63 acre/h

## NEW LEGEND

LIRA XL perfectly distributes big amount of stubble remains on the field.

It is the only harrow capable to work on dry soil in autumn, destroying soil crust and preventing moisture evaporation.

One of the unique features of the LIRA XL is a possibility to perform 5 different operations in one pass. For example, simultaneous early spring harrowing and loosening of topsoil to a depth of 2-10 cm (0.79"-3.94"):

- keeps moisture;
- encourages weeds to germinate to further destroy them;
- levels the soil and prepares it for seeding;
- incorporates fertilizers and pesticides;
- uniformly distributes stubble remains.





**Suspension of working sections**

Parallelogram suspension of individual working sections allows to keep contact with a rough soil. It provides perfect contour following alongside the whole section width and uniform distribution of load per each spring block.



**Adjustable attack angle**

Optimal harrowing is provided by adjustable teeth angle. Attack angle can be adjusted through the whole section within limits 45-90°.



**Pressure on the soil**

Spring block eliminates undesirable vibrations of sections (bouncing) at high speeds, and adjusts a pressure of the work section springs on the soil from 400 to 860 kg (882-1 896 lbs).



**Cable tightening of sections**

Flexible cables allow to simplify the design of the harrow, ensure wings rigidity and reduce stresses. They provide perfect turning maneuvering and contour following alongside the whole harrow width.



**Durable teeth**

Spring tooth is made of high quality special steel with double hardening. The tooth diameter is 16 mm (0.63"), but due to innovative technology the wear resistance is increased in two-three times with a high strength in an area subject to the torque stresses.





**Forged cross**

Forged crosses that connect central and side frames, in comparison to welded ones, provide higher durability and reliability.



**Convenience**

Fast and simple folding/unfolding. Transport wheels are designed for public roads and have adjustable turn angle, which ensures better maneuvering when moving or folding/unfolding. There are two possible positions of wheel axles for high speeds.

LIRA XL and LARI have unified frame design which allow to transfer heavy tooth harrow into drag harrow and vice versa. Thus, buying one implement and special set of parts a farmer gets two implement for the price of one.

### TECHNICAL DATA

	LIRA XL-15	LIRA XL-21
Working width, m; ft	15 /49'	21/69'
Tractor power, hp	min 160	min 300
Coupling with tractor	trailed	trailed
Basic weight, kg; lbs	5000/12.533	7905/17.427
Teeth spacing, mm; inch	60/2.36"	60/2.36"
Teeth tilt angle, °	45-90	45-90
Diameter of a spring tooth, mm; inch	16/0.63"	16/0.63"
Operating depth, cm; inch	2–10/0.79"-3.94"	2–10/0.79"-3.94"
Operating speed, km/h; mph	max 15/12	max 15/12
Efficiency, ha/h	max 12	max 25,2
Fuel consumption, l/ha; gal/ac	2-3/0.2-0.3	2-3/0.2-0.3
Transport dimensions (length x width x height), mm; inch	13160 x 4012 x 3995 518"×158"×157"	16160 x 4012 x 3995 636"×158"×157"



# LARI

## HEAVY TOOTH DRAG HARROW



TRADITIONAL  
and ORGANIC

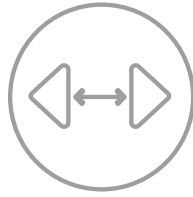

6,8-21 m  
22' - 69' ft



min 80 hp

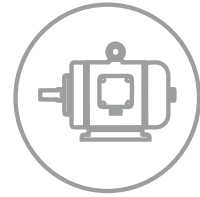

max 25,2 ha/h  
max 63 acre/h

## PERFECT EVEN FIELD

LARI drag harrow is versatile, simple and reliable implement with high efficiency and low fuel consumption. Main application – soil loosening and levelling, seedbed preparation, moisture retention and weeds destruction.

LARI makes it possible to start field works earlier than other implements in any weather conditions. For example, unlike a regular seedbed cultivator, the drag harrow is almost insensitive to soil moisture, because there is nothing to stick and block due to its efficient design.







**Uniform distribution of crop residues**

Uniform distribution of crop residues is an important precondition of operation quality of the machines that work the soil further. Hinged design provides distribution of any amount of crop residues even after the first pass.

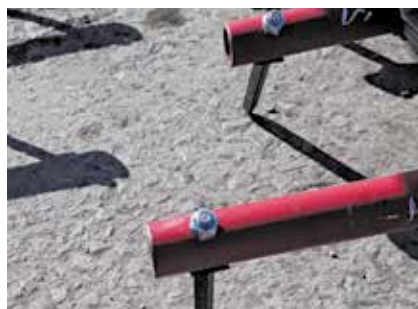

**Durable rhomb-shaped tooth**

The most durable tooth on the market is made of special spring steel with high surface hardness (55-60 HRC).



**Adjustable attack angle**

Two positions of teeth (active or passive) are suitable for any work conditions at depth from 3 cm to 8 cm (1.2"-3.15"). Sections suspended on chains provide perfect field contours following.

LIRA XL and LARI have unified frame design which allows to transfer heavy tooth harrow into drag harrow and vice versa. Thus, by buying one machine and a special set of parts, the farmer gets two machines for the price of one.

**TECHNICAL DATA**

	<b>LARI-7</b>	<b>LARI-12</b>	<b>LARI-15</b>	<b>LARI-18</b>	<b>LARI-21</b>
Working width, m; ft	6,8/19'	12,3/40'	14,1/46'	17,8/58'	21/69'
Tractor power, hp	min 80	min 135	min 160	min 240	min 300
Coupling with tractor	semi-trailed				
Weight, kg; lbs	3060/6.746	4393/9.684	4680/10.317	5421/11.951	6360/14.021
Teeth angles <sup>0</sup>	22 <sup>0</sup> ;40 <sup>0</sup>				
Working depth, cm; inch	8/3.15"				
Working speed, km/h; mph	20				
Efficiency, ha/h	max 8,1	max 15.3	max 17,5	max 21	max 25,2
Fuel consumption, l/ha; gal/ac	2-3/0.2-0.3				
Transport dimensions (length x width x height), mm; inch	4500 x 2560 x3550 177"x 100"x139"	10510 x 3000 x3455 423"x 118"x136"	11377 x 3000 x 3455 447"x 118"x136"	13191 x 3000 x 3455 519"x 118"x136"	16210 x 3000 x 3455 638"x 118"x136"

# COMPARISON OF TOOTH AND ROTARY HARROWS



**LIRA**  
SPRING-TOOTH HARROW



**LIRA XL**  
HEAVY TOOTH HARROW



**LARI**  
DRAG HARROW

Performed operation	LIRA	LIRA XL	LARI
Cereals stubble cultivation	—		—
Moisture retaining in spring on fallow land			
Moisture retaining in winter on winter crops		—	—
Destruction of weeds in the “white thread” phase		—	—
Seedbed preparation on the previously ploughed soil			
Inter-row harrowing	—	—	—
Soil aeration through sprouts		—	—



perfectly suitable



optimally suitable



suitable

— not suitable



## Seedbed preparation



# FLORIN

MULTIPURPOSE FIELD CULTIVATOR



TRADITIONAL  
and ORGANIC

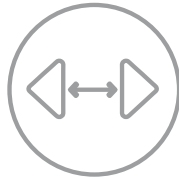

8 m  
26' ft



min 200 hp



max 9 ha/h  
max 22 acre/h

Field cultivator FLORIN is used for continuous pre-sowing soil cultivation, cultivation of light stubble and weed control.

The cultivator allows you to prepare the seedbed at a precisely defined depth and perfectly seals moisture.







Unique frame

One of the longest frames in its class is designed for operation without clogging. Soil, crop residues and chemicals are evenly mixed and distributed over the entire width of the unit and the depth of soil cultivation.

The distance between the rows of racks is 850 mm.

The distance between the first and last row of tines is 4150 mm.



Three options of tines

There are three options of tines:

- spring tine with cross section 30 x30
- spring-loaded tine of variable cross-section, which reduces resistance and power consumption
- spring damper.



Packing roller, tooth harrow

The original design of the roller does not have a central axis, so the roller is not clogged even in wet soil and foul field conditions.

The spring tooth is made of high-quality stainless steel with a special double heat treatment.

The resource of LOZOVA MACHINERY tooth is three times higher than that of other manufacturers.

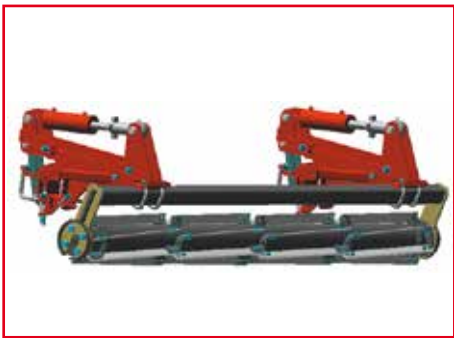

Possibility of working on stubble

Chopping roller is used for pre-crushing of stubble has blades made of boron steel for super-floatation on the stubble.



Additional cutting discs

The edge of each cutting turbo-disc enters the soil perpendicularly to the surface, providing the best longitudinal crushing of stubble.



Cultivation depth adjustment

It is necessary to ensure uniform cultivation depth to create an even seedbed layer.

The necessary cultivation depth is maintained by the support wheels.





### WIDE RANGE OF ADDITIONAL OPTIONS

The FLORIN field cultivator can be equipped according to your needs. For example, clients can choose the appropriate rack option depending on the intended work, weather conditions and field tasks. FLORIN can also be equipped with additional rollers (front chopping and rolling), front cutting discs and a two-row tooth spring harrow.

### TECHNICAL DATA

	<b>FLORIN-8</b>
Working width, m; ft	8/26'
Tractor power, hp.	min 200
Coupling with tractor	semi-trailed
Weight (depending on configuration), kg; lbs	5680-7460/12.522-16.446
Number of tines, pcs.	45
Number of working shares, pcs.	45
Operating depth, cm; inch	3-15/1'-6"
Operating speed, km/h; mph	10-15/6-9
Efficiency, ha/h; acre/h	max 9/22
Fuel consumption, l/ha; gal/ac	max 8/0.8
Transport dimensions (length x width x height), mm; inch	10387 x 3494 x 4000 408"x137"x157"

**LOZOVA MACHINERY implements are sold to more than 20 countries**

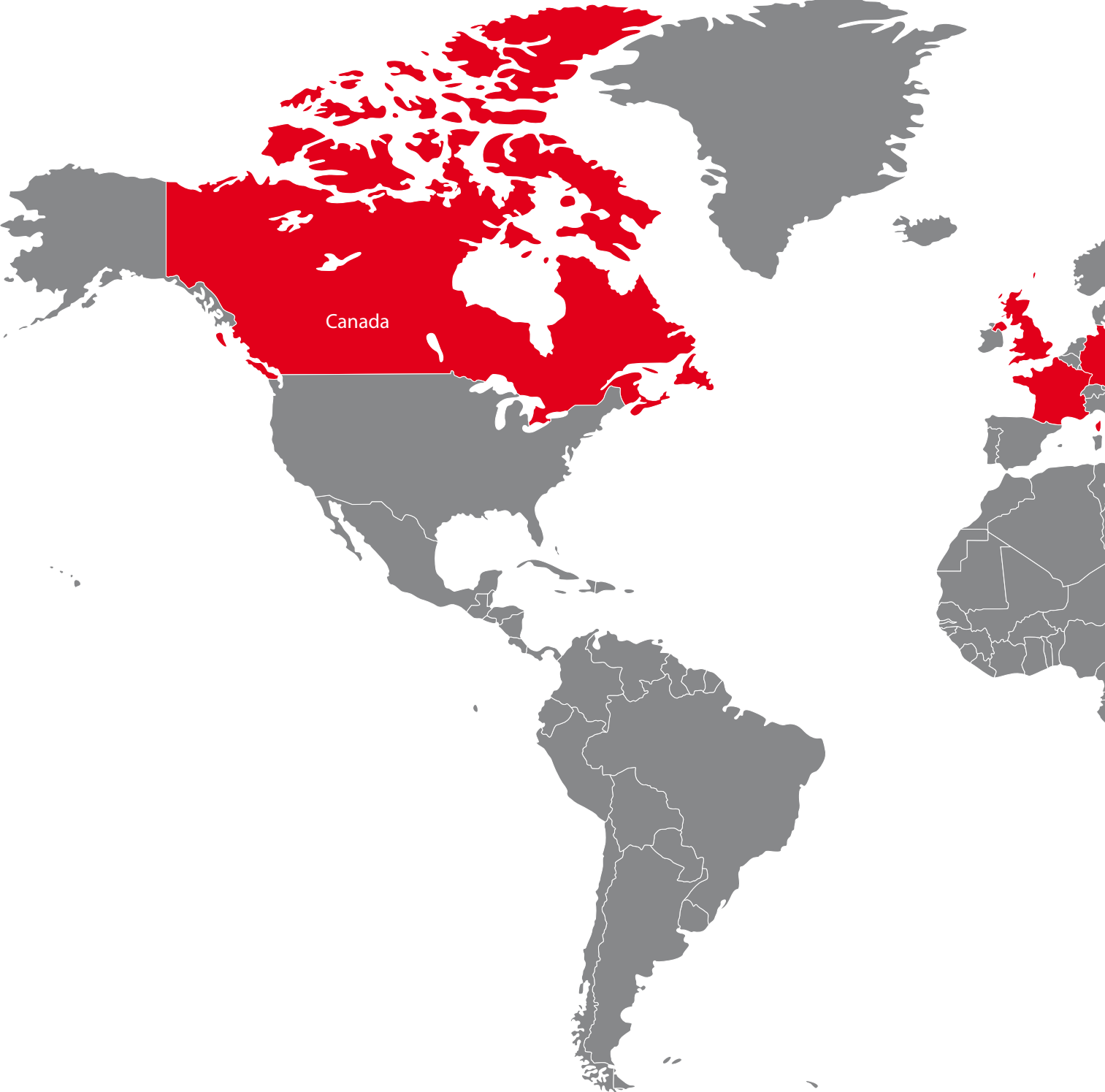

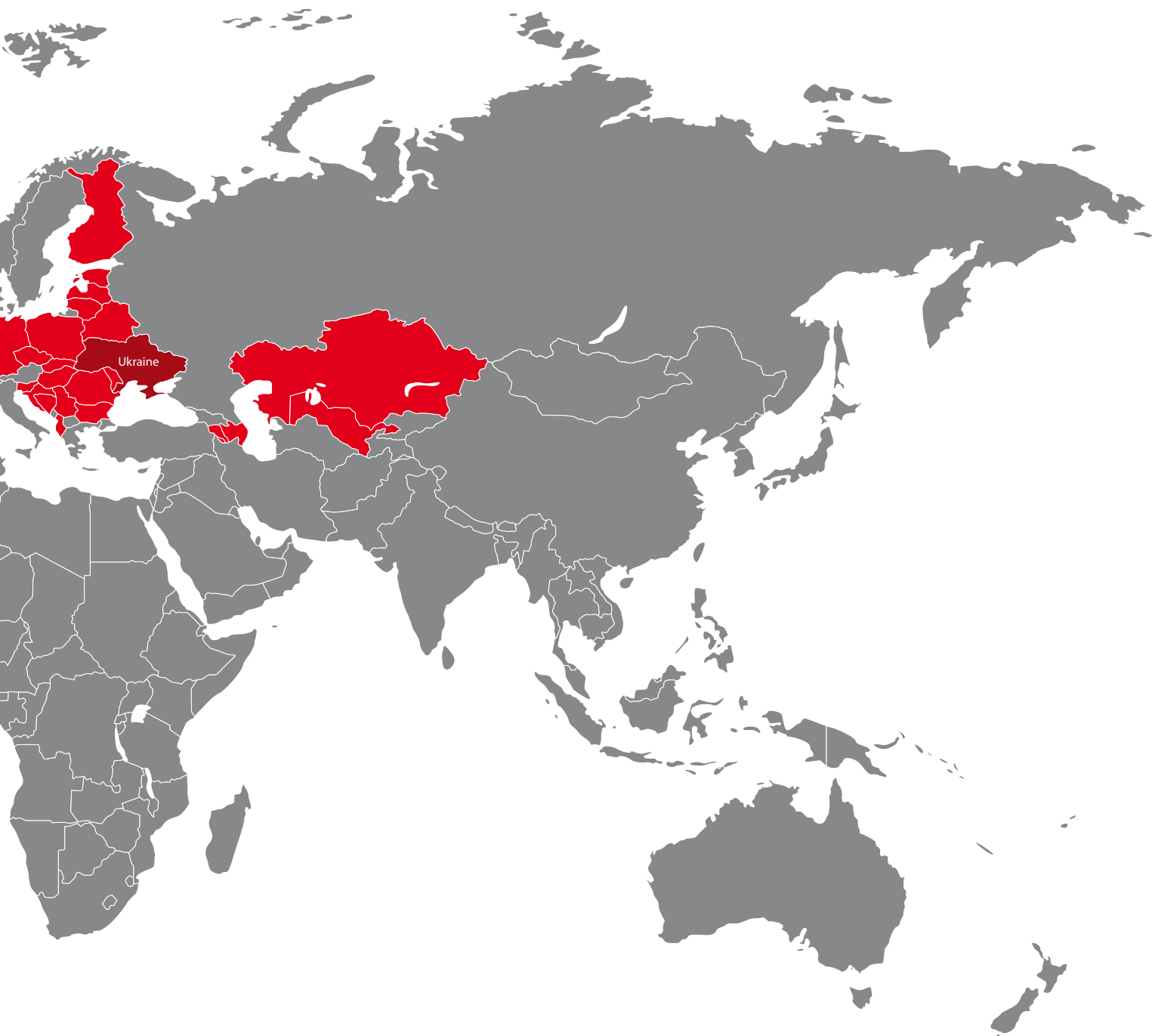





**LOZOVA  
MACHINERY**

LOZOVA MACHINERY PRODUCTION LLC

277, Heroiv Kharkova Ave., Kharkiv, 61089, Ukraine

+38 (063) 827-53-02

+38 (063) 209-36-22

[LMsales@upec.ua](mailto:LMsales@upec.ua)

[lozovamachinery.upec.ua/ca/](http://lozovamachinery.upec.ua/ca/)

[upec.ua/en/](http://upec.ua/en/)

OFFICIAL DISTRIBUTOR IN CANADA

Higginson Farm Equipment  
2682 Highway 34,  
Hawkesbury, Ontario  
K6A 0E5

+1 613-632-4747

+1 613-632-9488

[sales@higginsonequip.com](mailto:sales@higginsonequip.com)

[www.higginsonequip.com](http://www.higginsonequip.com)

